

# Prefabricating A Home



Mid Semester Seminar | Oikopolis M23 | Neerja Joshi

## The Age Of The Machine

Coming up of the factory

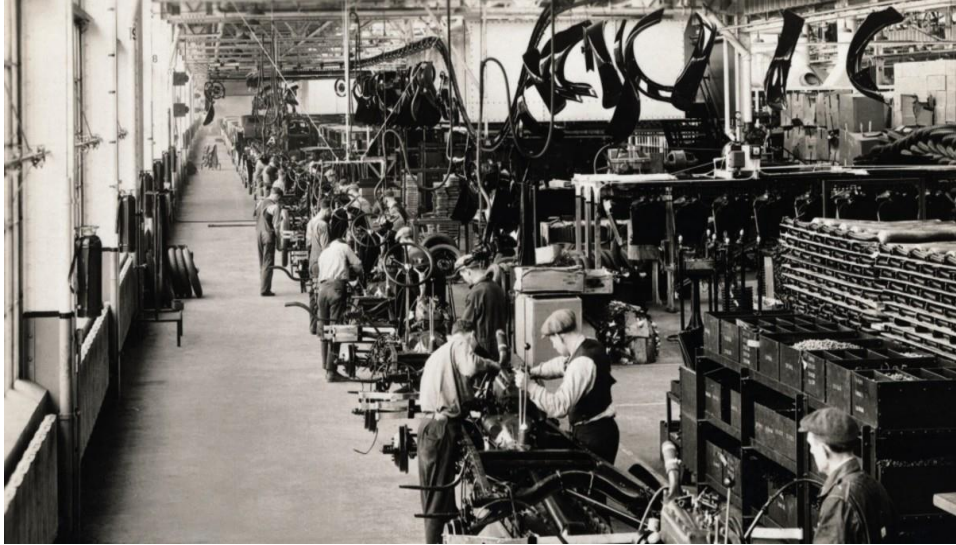

Large scale urban migration



## Industrialization: Building Industry

Mass housing



Prefabricated housing models



Dymaxion House, Buckminster Fuller



The Packaged House, Walter Gropius

## Industrialization: Indian Building Industry



## Current Scenario Of The Housing Industry

Abandonment of ongoing construction sites



Structural indurability



## Current Scenario Of The Housing Industry

Problems pre-occupation



Maintenance post-occupation



## What Is Prefabrication?



## Off The Shelf VS From Scratch

Mass produced wooden chairs



Self designed furniture, Frank Lloyd Wright - Robie House, Chicago





## Off The Shelf VS From Scratch

Mass produced chairs



Self designed chair, Mies Van Der Rohe – Barcelona Pavilion



## Off The Shelf VS From Scratch

Mass produced door handles



Self designed door handle, Zaha Hadid – 520 West, New York



## Off The Shelf VS From Scratch

Mass produced door handles



Self designed door handle, MAD – Absolute Towers - Toronto



## Prefabricating Components VS Modules

Parts of a door handle

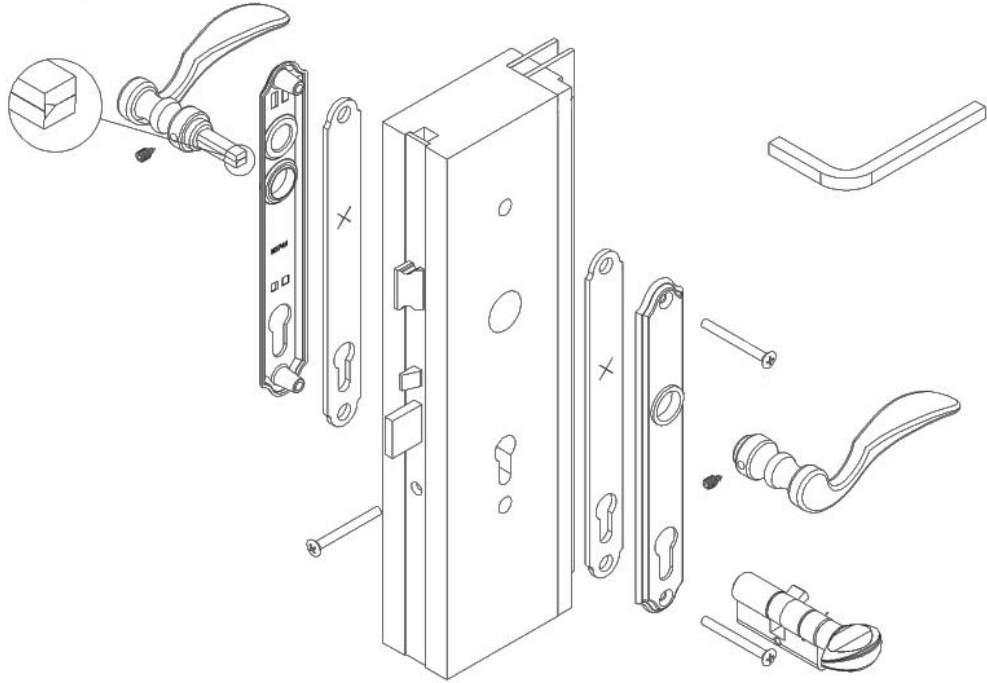

# Prefabricating Building Units

Mass produced bricks in a kiln



Customised bricks, O'Donnell + Tuomey – LSE Centre, London

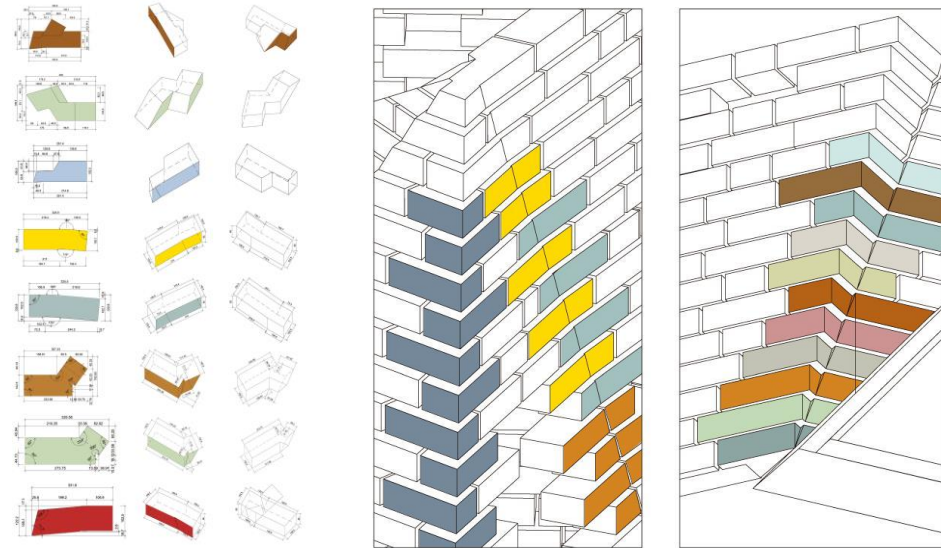

## Prefabricating Structural Components

Lagos House, MAPA - Uruguay



## Prefabricating Structural Components

SRA Scheme, VJTI Architects - Mumbai



## Prefabricating Housing Units

Dortheavej Residency, Bjarke Ingles - Denmark





## Prefabricating Housing Units

LA Star Apartments, Michael Maltzan – Los Angeles



## An Architect's Perspective

Prefabrication Off-Site

Vitra Fire Station, Zaha Hadid - Germany

An Idea, 1970s

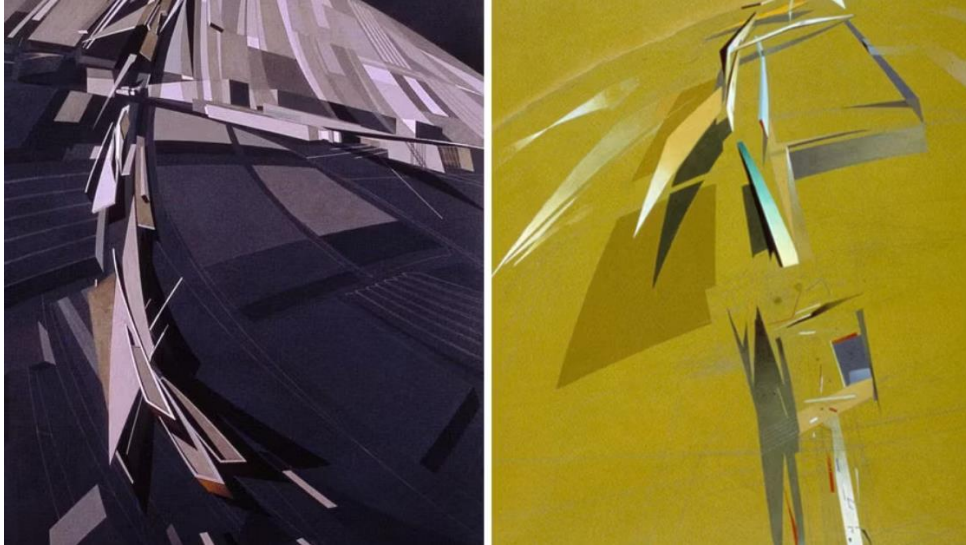

The Realization, 1993



# An Architect's Perspective

Prefabrication Off-Site

The Open Hand, Le Corbusier - Chandigarh

An Idea, 1943



The Realization, 1993



# An Architect's Perspective

Prefabrication Off-Site

Turning Torso, Le Santiago Calatrava - Sweden

An Idea, 1943

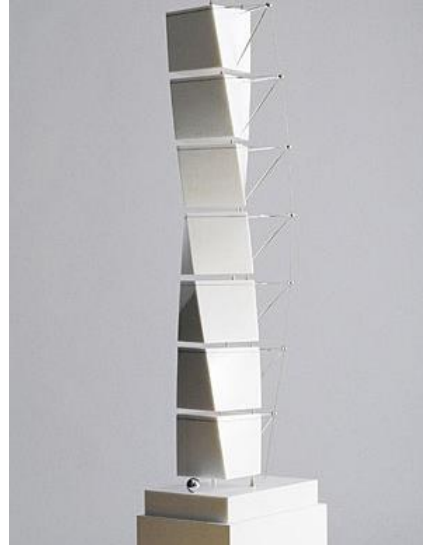
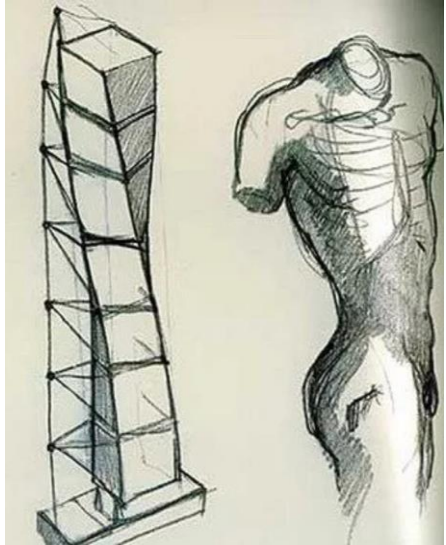

The Realization, 1993



# An Architect's Perspective

## Prefabrication Off-Site

Book of house plans, Apurva Amin, Jagrut + Partners – Housing in Ahmedabad

Prefabricated off-site

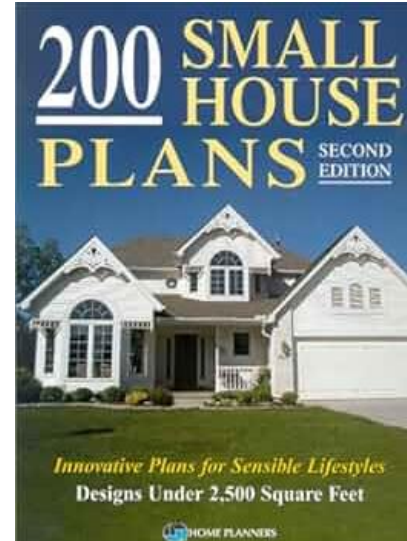
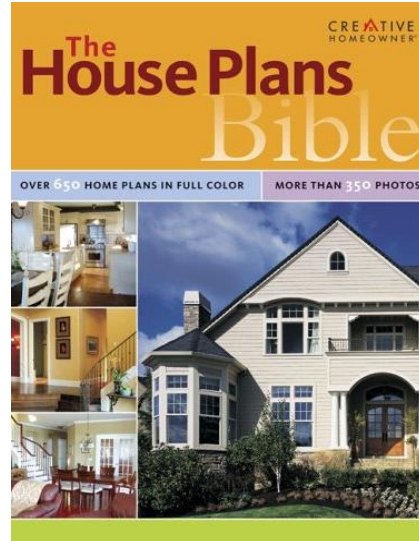
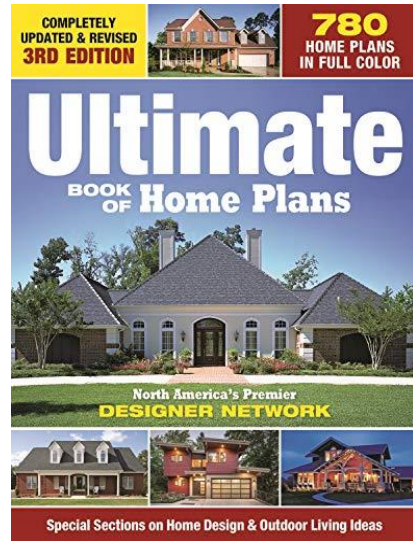

# An Architect's Perspective

## Prefabrication Off-Site

Real-world Time problems, Oikopolis L3 – CEPT University

Prefabricated off-site

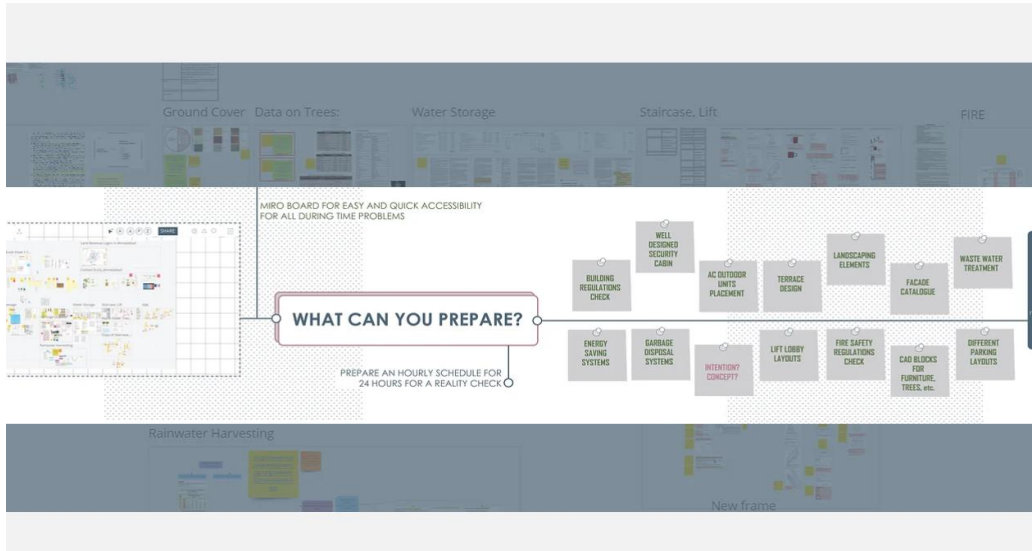

### TIME PROBLEM PREPARATION

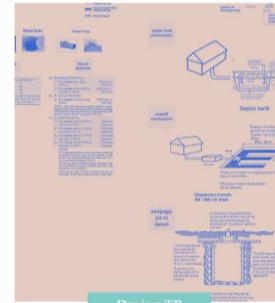

#### During Time Problem

This part of the preparation is to be accessed during time problems

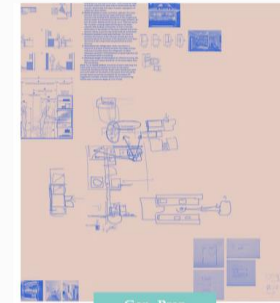

#### General Preparation

Preparation for doing a housing project in Ahmedabad in general



#### Ahmedabad Housing

A glance at the history of urban housing in Ahmedabad, urban housing websites and the development plan

## An Architect's Perspective

Casted On-Site

Jain Bungalow, Nari Gandhi - Maharashtra

A 'Concrete' Vision

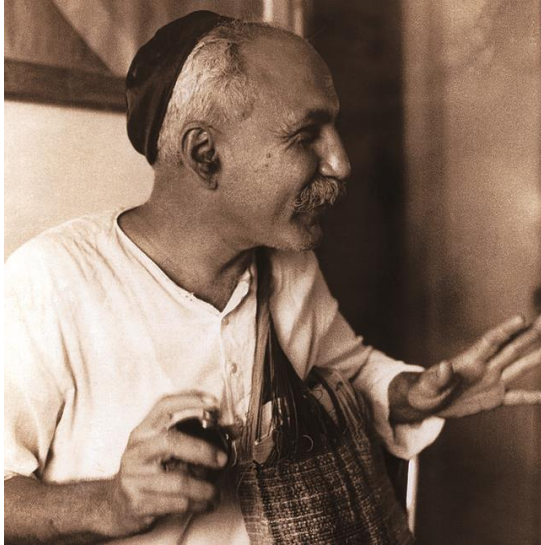

Casted on-site



## An Architect's Perspective

Prefabricated off-site



Casted on-site





## Can Ideas Be Prefabricated?

Prefabrication in factories



Pre-designing in studios



# Prefabricating An Idea

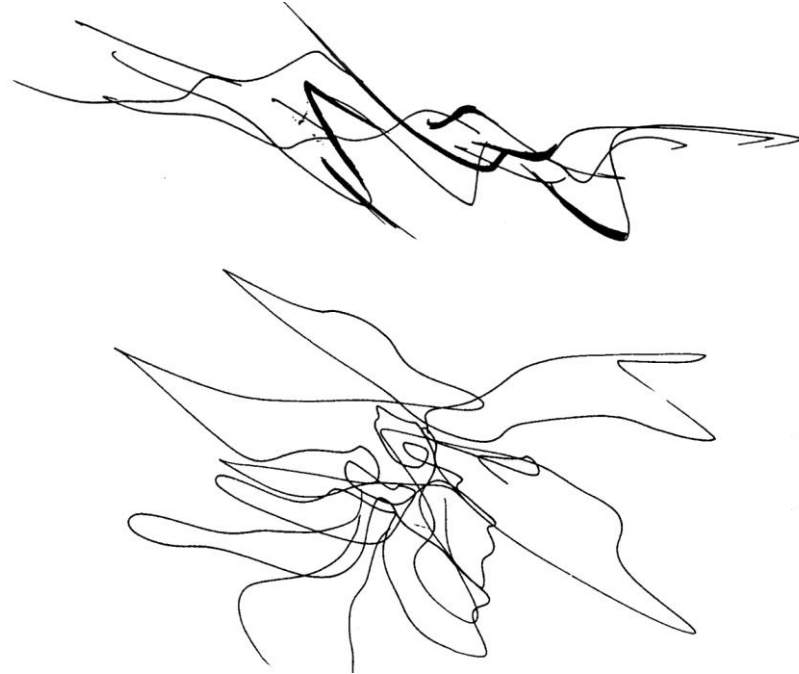

Mid Semester Seminar | Oikopolis M23 | Neerja Joshi